



mirplay

# tarimas

## stage

Sanlop  
EQUIPAMIENTO INTEGRAL



# tarit+ mas Fácil de montar...



Sistema de almacenamiento y transporte.

# y de recoger



Hemos preparado cuatro kits, con algunas de sus posibles combinaciones, para facilitarle la elección. Cada kit incluye paneles de madera y estructuras de metal de dos alturas para crear tarimas de un sólo nivel o varios niveles.

Si desea una combinación diferente, consúltenos.

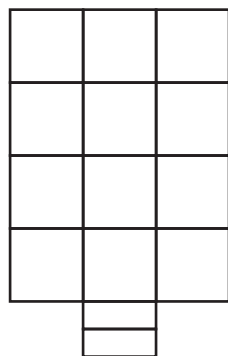

## Stage-0

8 estructuras 500mm  
8 estructuras 277,5mm  
12 paneles 750x750mm  
1 carro  
1 escalera

Dimensiones:  
2,25 x 3m

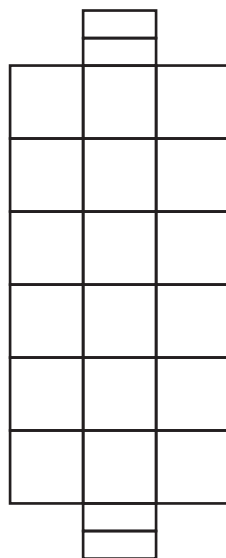

## Stage-1

12 estructuras 500mm  
12 estructuras 277,5mm  
18 paneles 750x750mm  
1 carro  
2 escaleras

Dimensiones:  
2,25 x 4,5m

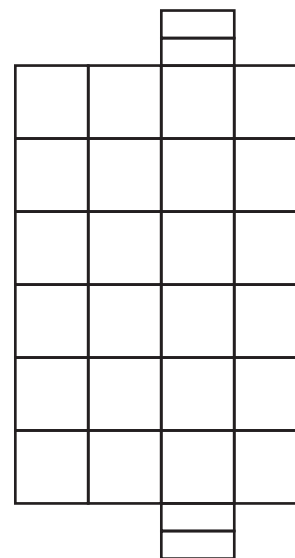

## Stage-2

18 estructuras 500mm  
12 estructuras 277,5mm  
24 paneles 750x750mm  
2 carros  
2 escaleras

Dimensiones:  
3 x 4,5m

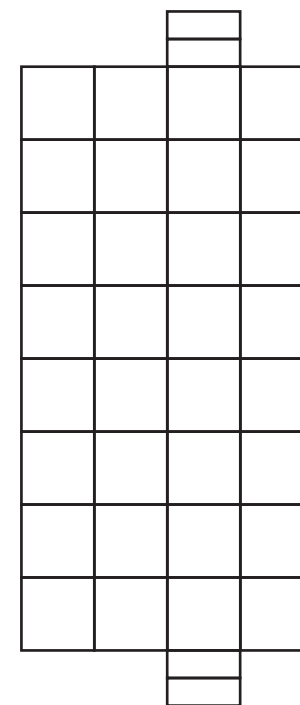

## Stage-3

24 estructuras 500mm  
16 estructuras 277,5mm  
32 paneles 750x750mm  
2 carros  
2 escaleras

Dimensiones:  
3 x 6m

# tarit+ mas Stage-0

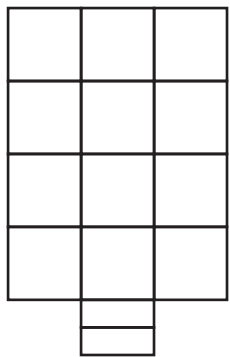

## Stage-0

- 8 estructuras 500mm
- 8 estructuras 277,5mm
- 12 paneles 750x750mm
- 1 carro
- 1 escalera

Dimensiones:  
2,25 x 3m

# Stage-0



# tarit mas Stage-1

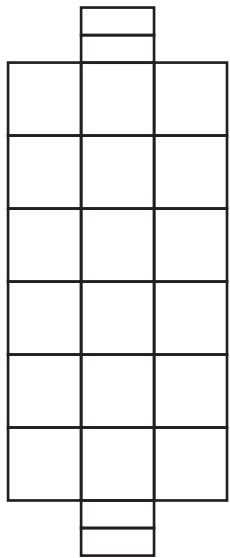

## Stage-1

12 estructuras 500mm  
12 estructuras 277,5mm  
18 paneles 750x750mm  
1 carro  
2 escaleras

Dimensiones:  
2,25 x 4,5m

# Stage-1





# tarit+ mas Stage-2

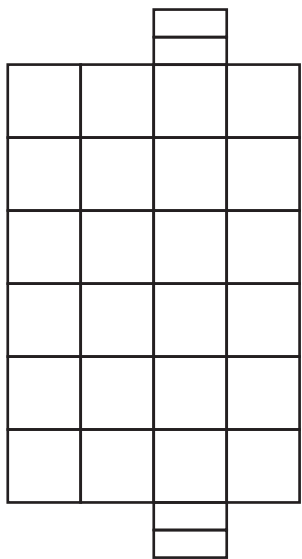

## Stage-2

18 estructuras 500mm  
12 estructuras 277,5mm  
24 paneles 750x750mm  
2 carros  
2 escaleras

Dimensiones:  
3 x 4,5m



# Stage-2



# tarit+ mas Stage-3

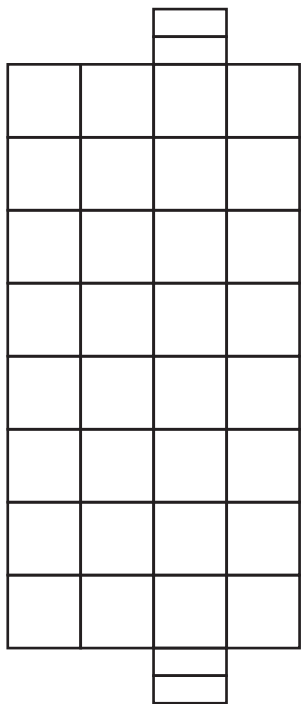

## Stage-3

24 estructuras 500mm  
16 estructuras 277,5mm  
32 paneles 750x750mm  
2 carros  
2 escaleras

Dimensiones:  
3x6m

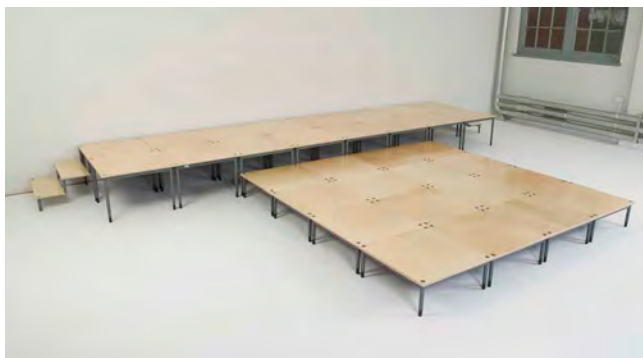

# Stage-3



# tarit+ mas Accesorios



Rampa para subir silla de ruedas en tarima de un nivel.



Rampa para subir silla de ruedas en tarima de dos niveles.

- 1** Barandillas de seguridad
- 2** Cortinas de fondo
- 3** Barra para cortinas
- 4** Adaptación triangular
- 5** Zócalo de cortina
- 6** Escaleras
- 7** Zócalo de madera

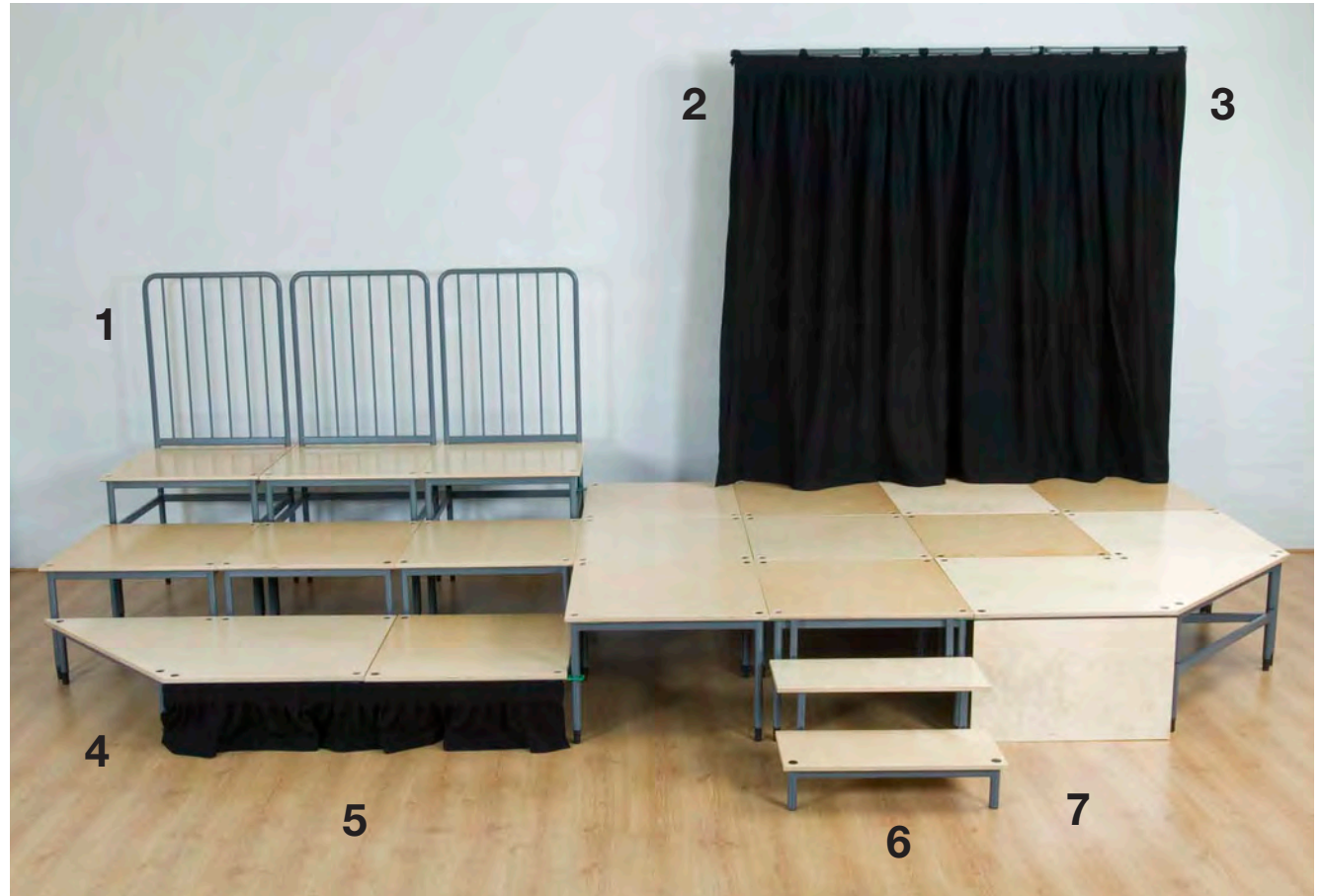

# tarit+ mas Datos técnicos

Las diferentes alturas de las estructuras nos permiten una gran versatilidad, ofreciendo la posibilidad de crear plataformas del mismo nivel o escalonadas.

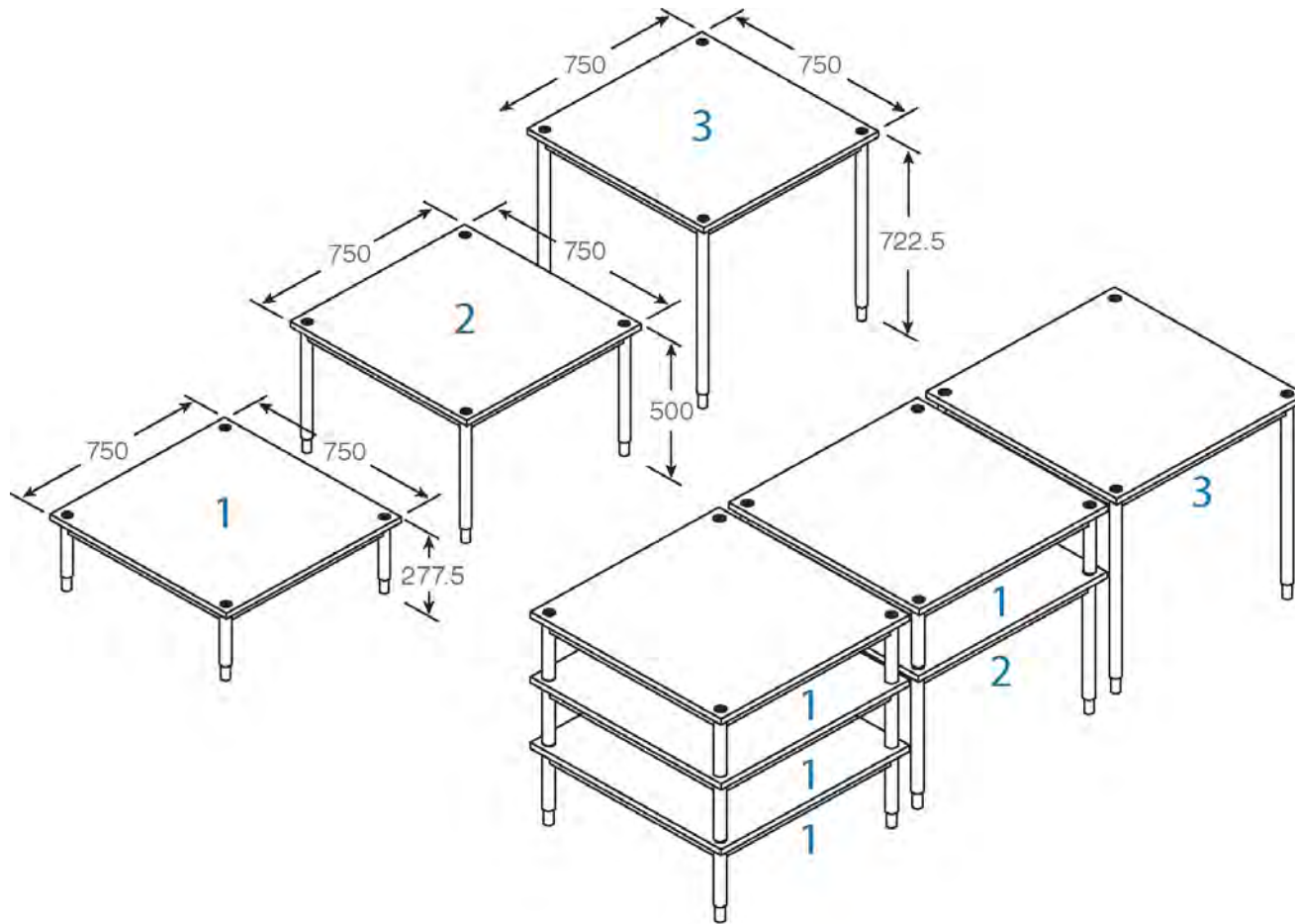

**Sanlop**  
EQUIPAMIENTO INTEGRAL

Santos Patronos, 27  
46135 Albalat dels Sorells,  
Valencia, ES  
T 961 480 901  
F 961 491 754

[www.sanlop.com](http://www.sanlop.com)